

# 90

ACC-90 (3)

# perLOTUS

ACCESSORI  
ACCESSORIES  
ZUBEHÖR  
ACCESSOIRES  
ACCESORIOS

## Cuocipasta / Pasta cookers / Nudelkocher / Cuiseurs à pâtes / Cuecepastas

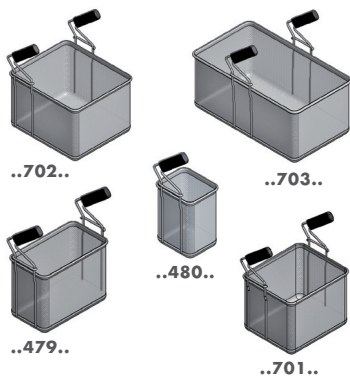

Cesto per cuocipasta e per sollevatore cesti  
Basket for pasta cookers and for basket elevator  
Korb für Nudelkocher und für Heben Korbe  
Panier pour cuiseurs à pâtes et pour soulever des paniers  
Cesta para cuecepastas y para levante cestas

Modelli / Models / Modelle / Modelos / Modelos	Per CP-94 / For CP-94 / Für CP-94 / Pour CP-94 / Para CP-94	Per CPB-98 / For CPB-98 / Für CPB-98 / Pour CPB-98 / Para CPB-98	Dimensioni / Dimensions / Abmessungen / Dimensions / Dimensiones	Peso/Volume / Weight/Volume / Gewicht/Volumen / Poids/Volume / Peso/Volumen
			cm	kg/m <sup>3</sup>
<b>531070300</b>	<b>1/1 s</b>	<b>1/1 s *</b>	28x49x21,5h	3,5 / 0,060
<b>531070200</b>	<b>2/3 s</b>	<b>2/3 s *</b>	28x32x21,5h	2 / 0,040
<b>531070100</b>	<b>1/2 s</b>	<b>1/2 s *</b>	28x24x21,5h	1 / 0,031
<b>531047900</b>	<b>1/3 s</b>	<b>1/3 s *</b>	28x16x21,5h	1,5 / 0,020
<b>531048000</b>	<b>1/6 s</b>	<b>1/6 s *</b>	13,5x16x21,5h	1 / 0,013

\* Combinazioni x 2 / Combinations x 2 / Zusammenstellungen x 2 / Combinaisons x 2 / Combinación múltiple x 2

## Fry-top / Fry-tops / Griddleplatten / Plaques / Fry-top



Raschietto per piastra rigata / Scraper for grooved plate  
Schaber für gerillte Kochplatte / Racloir pour plaque nervurée  
Rasqueta para placa ranurada

Modelli / Models / Modelle / Modelos / Modelos
<b>544023800</b>

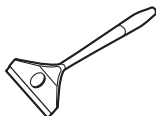

Raschietto per piastra liscia cromata  
Scraper for smooth chromed plate  
Schaber für glatte verchromte Platte  
Racloir pour plaque lisse au chrome  
Rasqueta para placa lisa cromada

Modelli / Models / Modelle / Modelos / Modelos
<b>531040800</b>



Kit 10 lame per raschietto / 10 blades kit for scraper  
Kit 10 klingen für Schaber / Kit de 10 lames pour racloir  
Kit de 10 cuchillas para rasqueta

Modelli / Models / Modelle / Modelos / Modelos
<b>531040900</b>



Tappo per fry-top  
Stopper for fry-top  
Stopfen Griddleplatte  
Bouchon pour fry-top  
Tapón fry-top

Modelli / Models / Modelle / Modelos / Modelos	Dimensioni / Dimensions / Abmessungen / Dimensions / Dimensiones
<b>T-FT</b>	cm 10x2x5h

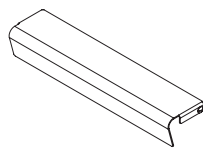

Kit protezione frontale piano fry-top  
Kit front protection plan fry-top  
Schutz-kit vorne Plan Griddleplatte  
Kit protection avant plan fry-top  
Kit de proteccion front plan de fry-top

Modelli / Models / Modelle / Modelos / Modelos	Dimensioni / Dimensions / Abmessungen / Dimensions / Dimensiones
	cm
<b>PFT-94</b>	35x11x6h
<b>PFT-98</b>	75x11x6h

## Griglie / Grills / Würst Brater / Grilles / Barbacoas

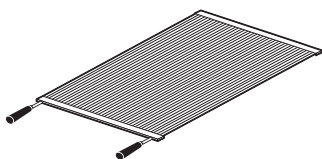

Griglia tondino e V per CW  
Grid ● and V for CW  
Gritter ● und V für CW  
Grille ronde et V pour CW  
Rejilla ● y V para CW

Modelli / Models / Modelle / Modelos / Modelos	Griglia - Forma / Grid - Form / Gritter - Form / Grille - Forme / Rejilla - Forma	Dimensioni / Dimensions / Abmessungen / Dimensions / Dimensiones	Peso/Volume / Weight/Volume / Gewicht/Volumen / Poids/Volume / Peso/Volumen
		cm	kg/m <sup>3</sup>
<b>09570401</b>	●	38x68	12 / 0,015
<b>09570402</b>	V	38x68	12 / 0,015

18.07.2016



FOOD CATERING EQUIPMENT



perLOTUS

Brasiere / Bratt-pans / Kippbratpfannen / Sauteuses / Sartenes



Coperchio  
Lid  
Deckel  
Couvercle  
Tapa

Modelli Models Modele Modelos	Per BRF-94 Für BRF-94 Für BRF-94 Pour BRF-94 Para BRF-94	Per BRF-98 Für BRF-98 Für BRF-98 Pour BRF-98 Para BRF-98	Dimensioni Dimensions Abmessungen Dimensions Dimensiones	Peso/Volume Weight/Volume Gewicht/Volumen Poids/Volume Peso/Volumen
			cm	kg/m <sup>3</sup>
<b>09550400</b>	●		32x70x5h	2,5 / 0,020
<b>09550800</b>		●	72x70x5h	5 / 0,040

Friggitrici / Fryers / Friteusen / Friteuses / Freidoras

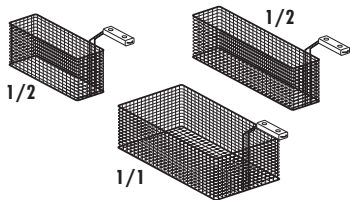

Cestini  
Baskets  
Korbe  
Paniers  
Cestas

Modelli Models Modele Modelos	Per F23P-G Für F23P-G Für F23P-G Pour F23P-G Para F23P-G	Per F18-E Für F18-E Für F18-E Pour F18-E Para F18-E	Per F18-70G Für F18-70G Für F18-70G Pour F18-70G Para F18-70G	Per F25-G/E Für F25-G/E Für F25-G/E Pour F25-G/E Para F25-G/E	Dimensioni Dimensions Abmessung. Dimensions Dimensiones	Peso/Volume Weight/Volume Gewicht/Volumen Poids/Volume Peso/Volumen
					cm	kg/m <sup>3</sup>
<b>531041600</b>		1/2			13,5x29x15	0,8 / 0,015
<b>531041500</b>			1/2		10x45x15	0,8 / 0,015
<b>531041400</b>				1/1	28x45x15	1,5 / 0,035
<b>531069600</b>	1/1				28x39x15	1,5 / 0,035

Kit scioglimento strutto, solo per friggitrici elettriche a mobile.  
Kit for lard melting, only for electric fryers on cabinet.  
Satz fuer schmalzschmelzen, nur für elektrische Friteusen mit unterbau.  
Kit de dissolution lard, seulement pour les friteuses électriques sur armoire.  
Kit de disolución de manteca, sólo para freidoras eléctricas on mueble.

Modelli Models Modele Modelos	Potenza totale Total power Gesamtleistung Puissance total Potencia total	Voltaggio e frequenza Voltage and frequency Spannung und Freq. Tension et fréquence Voltaje y frecuencia
	kW	V~ • Hz
<b>KITSS-90</b>	⚡ 0,31	230V~ • 50/60

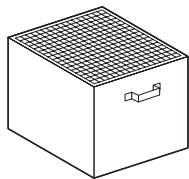

Bacinella raccogli olio  
Kit for lard melting  
Fettauffang Schublade  
Kit de dissolution lard  
Kit de disolución de manteca

Modelli Models Modele Modelos	Dimensioni Dimensions Abmessungen Dimensions Dimensiones	Capacità Capacity Kapazität Capacité Capacidad	Peso/Volume Weight/Volume Gewicht/Volumen Poids/Volume Peso/Volumen
	cm	lt	kg/m <sup>3</sup>
<b>BF30</b>	29x29x37h	30	7 / 0,050

Pentole / Pans / Kessel / Marmites / Marmitas

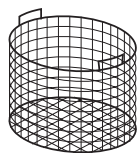

Cesto 1/1 per pentola  
Basket 1/1 for boiling pan  
Korb 1/1 für Kochkessel  
Panier 1/1 pour marmite  
Cesta 1/1 por marmita

Modelli Models Modele Modelos	Vasca Tank Becken Cuve Cuba	Dimensioni Dimensions Abmessungen Dimensions Dimensiones	Peso/Volume Weight/Volume Gewicht/Volumen Poids/Volume Peso/Volumen
	lt	cm	kg/m <sup>3</sup>
<b>531043401</b>	100	Ø56x34,5h	5 / 0,044
<b>531043501</b>	150	Ø56x47h	5 / 0,044

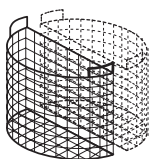

Cesto 1/2 per pentola  
Basket 1/2 for boiling pan  
Korb 1/2 für Kochkessel  
Panier 1/2 pour marmite  
Cesta 1/2 por marmita

Modelli Models Modele Modelos	Vasca Tank Becken Cuve Cuba	Dimensioni Dimensions Abmessungen Dimensions Dimensiones	Peso/Volume Weight/Volume Gewicht/Volumen Poids/Volume Peso/Volumen
	lt	cm	kg/m <sup>3</sup>
<b>531043601</b>	100	Ø56x34,5h	2,5 / 0,022
<b>531043701</b>	150	Ø56x47h	2,5 / 0,022



Imbuto per scarico pentole  
Channel for pan drainage  
Trichter zum Entleeren der Töpfe  
Entonnoir pour vidange marmites  
Embudo para descargar marmitas

Modelli Models Modele Modelos	Peso/Volume Weight/Volume Gewicht/Volumen Poids/Volume Peso/Volumen
	kg/m <sup>3</sup>
<b>ISP</b>	5 / 0,030