

# 65

ACC-65 (1)

# magleprof

ACCESSORI  
ACCESSORIES  
ZUBEHÖR  
ACCESSOIRES  
ACCESORIOS

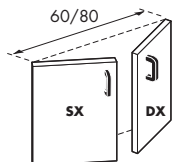

Porta 300/400  
Door 300/400  
Tür 300/400  
Porte 300/400  
Puerta 300/400

Modelli Models Modele Modelos	Porta destra Right door Rechte Tür Porte droite Puerta derecha	Porta sinistra Left door Linke Tür Porte gauche Puerta izquierda	Dimensioni Dimensions Abmessungen Dimensions	Peso/Volume Weight/Volume Gewicht/Volumen Poids/Volume Peso/Volumen
			<b>cm</b>	<b>kg/m<sup>3</sup></b>
<b>PM-3DX</b>	●		29,5x2,5x45h	2,5 / 0,010
<b>PM-3SX</b>		●	29,5x2,5x45h	2,5 / 0,010
<b>PM-4DX</b>	●		39,5x2,5x45h	3,5 / 0,010
<b>PM-4SX</b>		●	39,5x2,5x45h	3,5 / 0,010

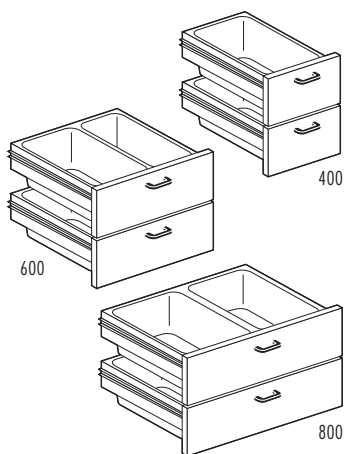

Modelli Models Modele Modelos	Cassetto inox Stainless steel drawer Schublade aus Nirosta Tiroir en acier inox Cajón en acero inox.	Bacinelle inox Stainless steel containers Behältern aus Nirosta Bacs en acier inox Contened. en acero inox.	Bacinelle in plastica Plastic containers Kunststoffbehältern Bacs en plastique Contened. en acero inox.	Guide telescopiche Telescopic guides Telescopieinführungen Guides télescopiques Guías telescópicas	Dimensioni Dimensions Abmessungen Dimensions	Peso/Volume Weight/Vol. Gewicht/Vol. Poids/Volume Peso/Volumen
	N°	N° • cm	N° • GN • cm		<b>cm</b>	<b>kg/m<sup>3</sup></b>
<b>C-4</b>	2		2 • GN 1/1 - 15h	●	39,5x56x45h	18 / 0,110
<b>C-6</b>	2	2 • 17x46,5x15h	2 • GN 1/1 - 15h	●	59,5x56x45h	24 / 0,170
<b>C-8</b>	2		4 • GN 1/1 - 15h	●	79,5x56x45h	26 / 0,220

Cassettiere 400 / 600 / 800  
Drawer set 400 / 600 / 800  
Schubladen 400 / 600 / 800  
Tiroirs pour meuble de 400 / 600 / 800  
Cajoneras 400 / 600 / 800

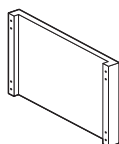

Divisorio (per applicare cassetiera C-4 su mobile M-8)  
Spacer (for installation of C-4 on stand M-8)  
Trennwand (um ein C-4 an einem Unterschrank M-8 einzubauen)  
Separation (pour l'installation de C-4 sur placard M-8)  
Divisorio (necesario para aplicar cajoneras C-4 en mueble M-8)

Modelli Models Modele Modelos	Dimensioni Dimensions Abmessungen Dimensions	Peso/Volume Weight/Volume Gewicht/Volumen Poids/Volume Peso/Volumen
	<b>cm</b>	<b>kg/m<sup>3</sup></b>
<b>D-8</b>	5x53,5x38,5h	2 / 0,015

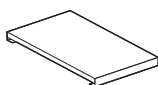

Ripiano 300 / 400 / 600  
Shelf 300 / 400 / 600  
Zwischenboden 300 / 400 / 600  
Etagère 300 / 400 / 600  
Estante 300 / 400 / 600

Modelli Models Modele Modelos	Dimensioni Dimensions Abmessungen Dimensions	Ripiano Shelf Etagère Estante	Peso/Volume Weight/Volume Gewicht/Volumen Poids/Volume Peso/Volumen
	<b>cm</b>		<b>kg/m<sup>3</sup></b>
<b>R-4</b>	35x53x2h	400	1,5 / 0,005
<b>R-6</b>	55x53x2h	600	2 / 0,008
<b>R-8</b>	75x53x2h	800	2,5 / 0,010

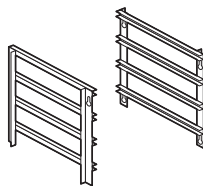

Portateglie vano 400 / 600  
Frame for plates 400 / 600  
Auflangeschienen für Bleche 400 / 600  
Kit porte-plaques 400 / 600  
Portacazuelas 400 / 600

Modelli Models Modele Modelos	Dimensioni Dimensions Abmessungen Dimensions	Ripiani Shelves Etagen Etagères Estantes	Interasse Wheel-base Abstand Entraxe Distancia	Peso/Volume Weight/Volume Gewicht/Vol. Poids/Vol. Peso/Vol.
	<b>cm</b>	<b>N°</b>	<b>cm</b>	<b>kg/m<sup>3</sup></b>
<b>PT</b>		4	9	2 / 0,015

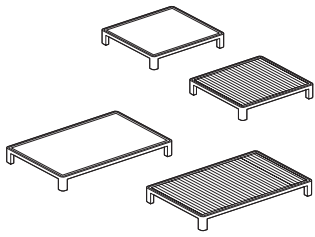

Piastra (per griglie in ghisa)  
 Plate (for cast iron grid)  
 Platte (für Gusseisen Rost)  
 Plaque (pour la grille en fonte)  
 Plancha (para rejilla de hierro colado)

Modelli / Models / Modelle / Modelos	1 fuoco / 1 burner / 1 Kochstelle / 1 feu / 1 quemadore	2 fuochi / 2 burners / 2 Kochstellen / 2 feux / 2 quemadores	Liscia / Smooth / Glatt / Lisse / Lisa	Rigata / Grooved / Gerillt / Nervurée / Estriada	Dimensioni / Dimensions / Abmessungen / Dimensiones	Peso / Volume / Weight / Vol. / Gewicht / Vol. / Poids / Volume / Peso / Volumen
					cm	kg/m <sup>3</sup>
<b>PLF</b>	●		●		35x27	9 / 0,005
<b>PLF/2</b>		●	●		35x57	18 / 0,010
<b>PRF</b>	●			●	35x27	9 / 0,005
<b>PRF/2</b>		●		●	35x57	18 / 0,010



Griglia di riduzione  
 Reduction  
 Reduzierstern  
 Grille de réduction  
 Rejilla de reducción

Modelli / Models / Modelle / Modelos	Dimensioni / Dim. / Abmess. / Dimens. / Dimensiones	Peso / Volume - Weight / Volume / Gewicht / Volum. - Poids / Volume / Peso / Volumen
	cm	kg/m <sup>3</sup>
<b>533009200</b>	25x25	0,2 / 0,001

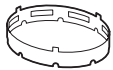

Anello per Wok - Solo per griglie in ghisa  
 Wok ring - Only for cast iron grills  
 Wok Aufsatzring - Nur für Roste aus Gusseisen  
 Anneau Wok - Seulement pour grilles en fonte  
 Anillo Wok - Solo para parrillas de hierro colado

Modelli / Models / Modelle / Modelos	Dimensioni / Dimens. / Abmessung. / Dimens. / Dimensiones	Peso / Volume - Weight / Volume / Gew. / Vol. - Poids / Vol. - Peso / Vol.
	cm	kg/m <sup>3</sup>
<b>544439900</b>	Ø22,5x3,5h	2 / 0,006

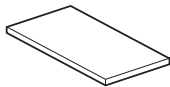

Tagliere plastica  
 Plastic chopping-board  
 Schneidebrett  
 Plan de decoup  
 Picador de plástico

Modelli / Models / Modelle / Modelos	Dimensioni / Dimens. / Abmess. / Dimens. / Dimensiones	Peso / Volume - Weight / Volume / Gewicht / Vol. - Poids / Vol. - Peso / Vol.
		kg/m <sup>3</sup>
<b>TG-4</b>	39x58x2,5h	6 / 0,015
<b>TG-6</b>	59x58x2,5h	8,5 / 0,020
<b>TG-8</b>	79x58x2,5h	11 / 0,025
<b>TG-10</b>	99x58x2,5h	14 / 0,030

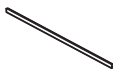

Coprigiunto  
 Joint cover / Klemmsteg  
 Couvre-joint / Cubre junta

Modelli / Models / Modelle / Modelos	Dim. / Dim. / Abmessungen / Dimens. / Dimensiones	Peso / Volume - Weight / Volume / Gew. / Vol. - Poids / Vol. - Peso / Vol.
	cm	kg/m <sup>3</sup>
<b>CG-65</b>	0,7x58x1,2h	0,1 / 0,0001

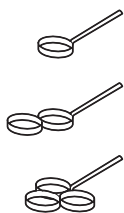

Forma per uova  
 Egg poachers  
 Eierformer  
 Forme a oeuf  
 Mode para huevos

Modelli / Models / Modelle / Modelos	Uova / Eggs / Eier / Oeuf / Huevos	N.	Ø cm	Peso / Volume - Weight / Volume / Gew. / Vol. - Poids / Vol. - Peso / Vol.
				kg/m <sup>3</sup>
<b>FU-1X7</b>	1	1	7	1 /
<b>FU-1X9</b>	1	1	9	1 /
<b>FU-2X7</b>	2	2	7	1,5 /
<b>FU-2X9</b>	2	2	9	1,5 /
<b>FU-3X7</b>	3	3	7	2 /
<b>FU-3X9</b>	3	3	9	2 /